





















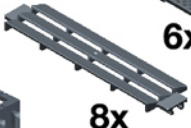

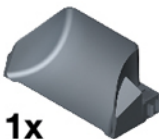



Skip Track with Storage Silo

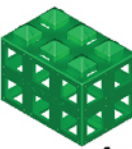

								
19x	5x	2x	2x	1x	13x	6x	9x	1x
								
3x	4x	1x	2x	6x	1x	1x	1x	24x
								
30x	30x	1x	1x	1x	4x	2x	2x	2x
								
								2x

Color of building pieces may differ from those shown.

1

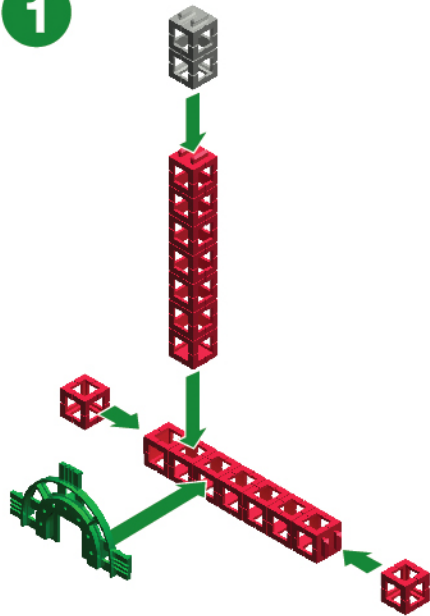

2

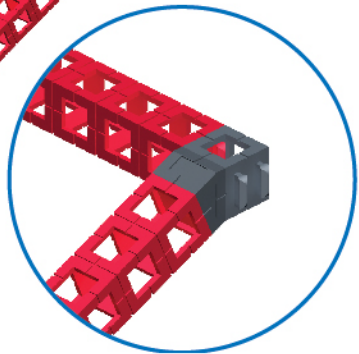
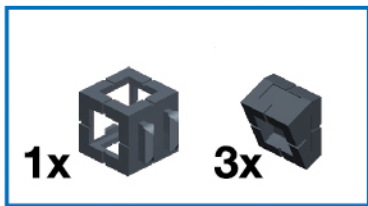
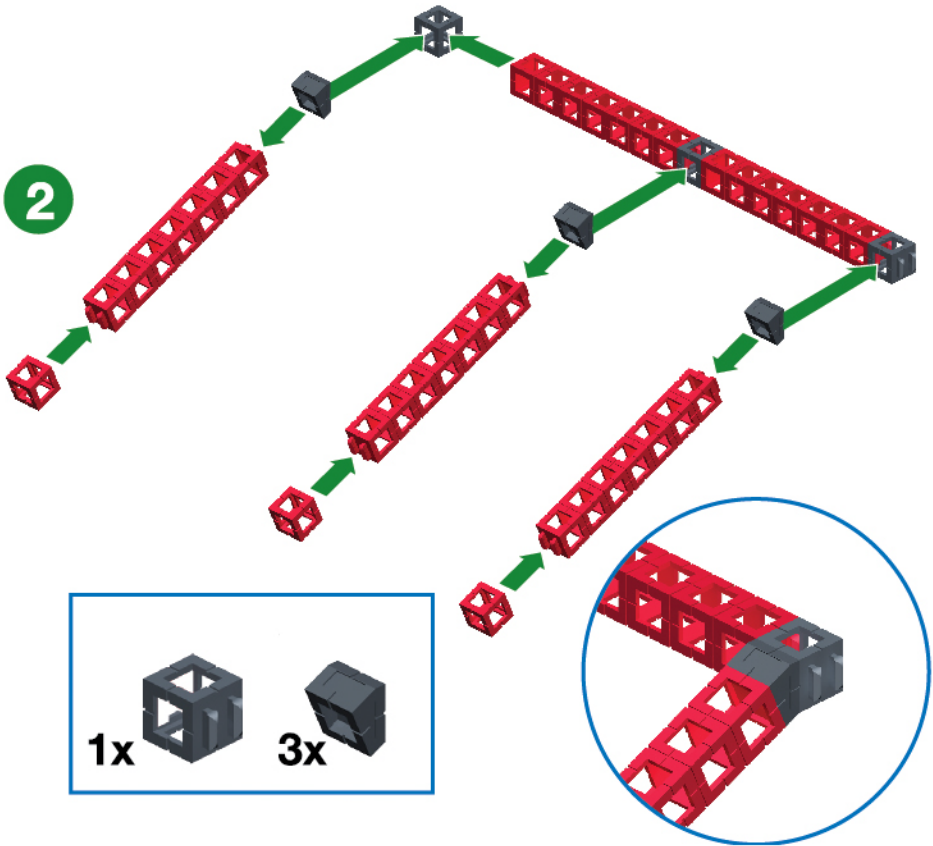

3

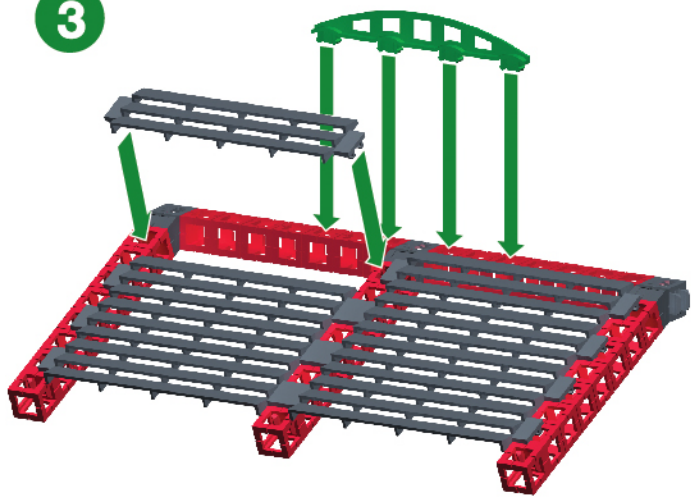

4

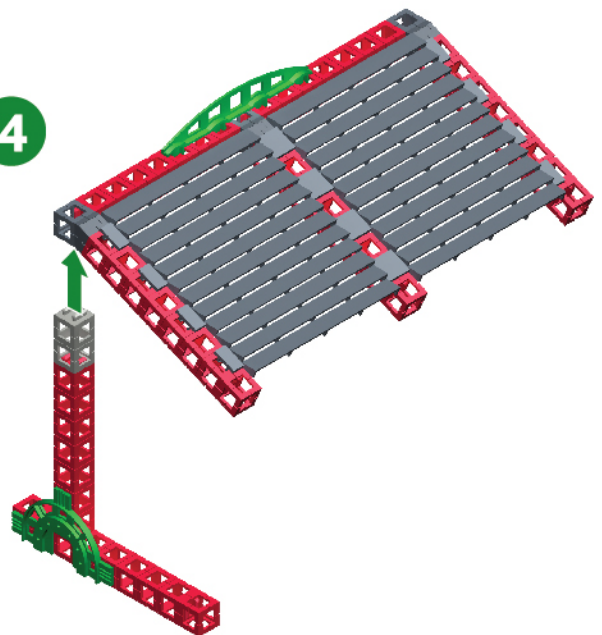

5

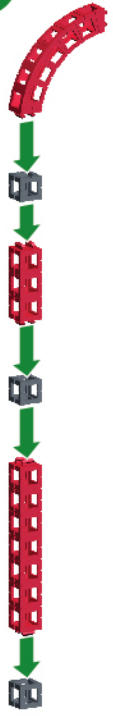

6

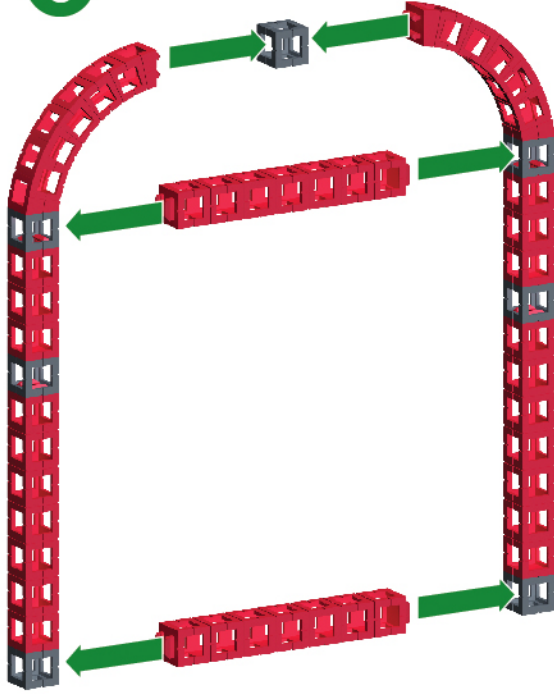

7

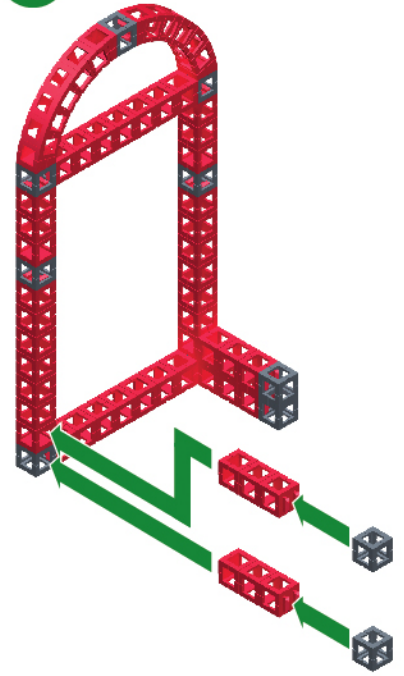

8

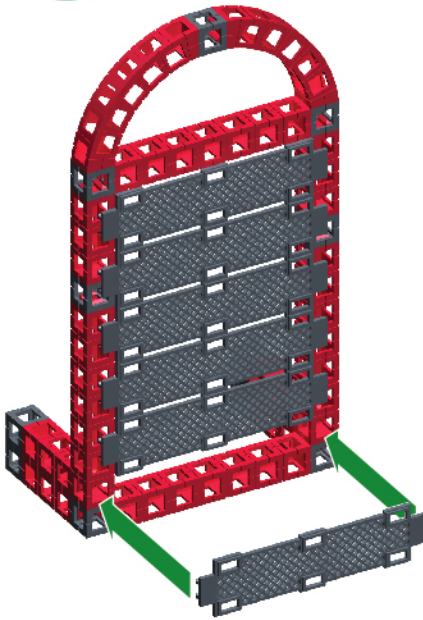

9

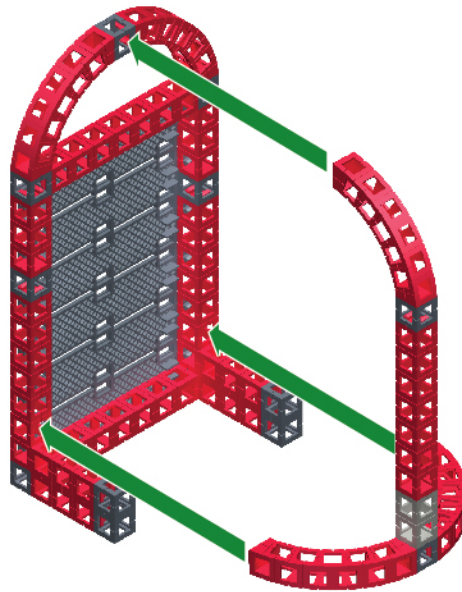

10

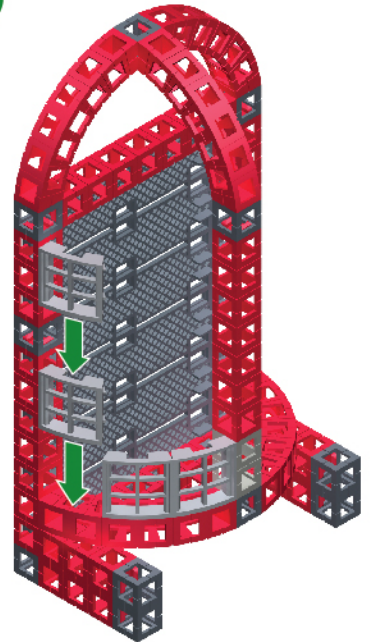

11

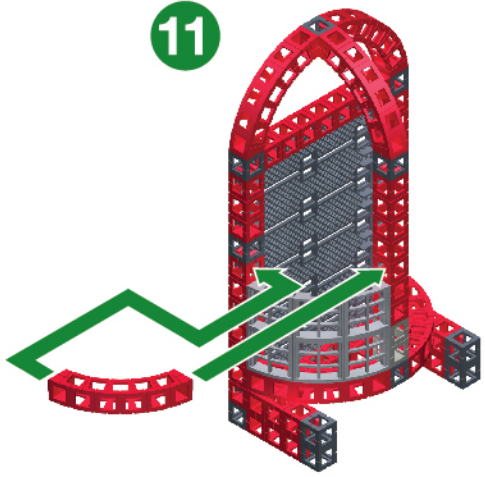

12

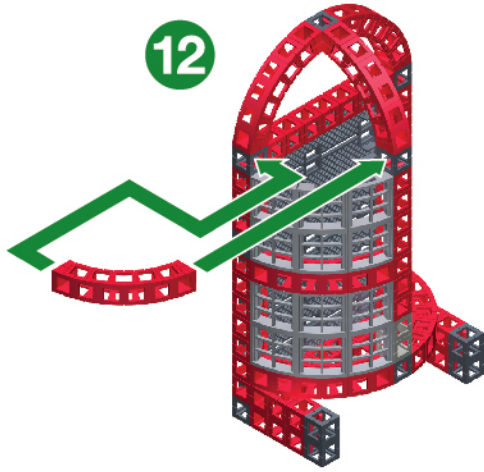

13

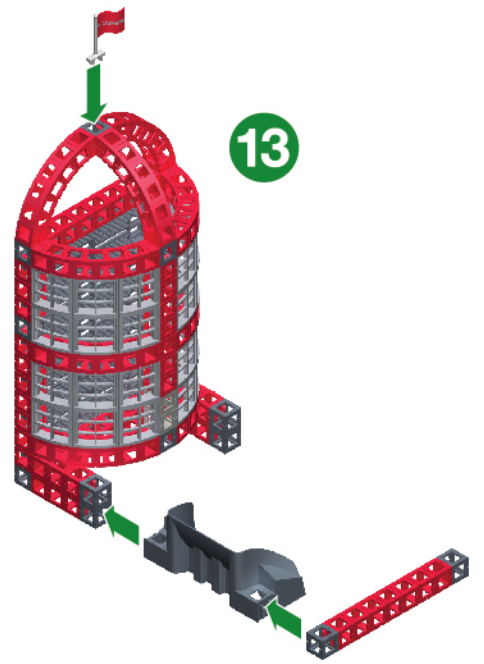

14

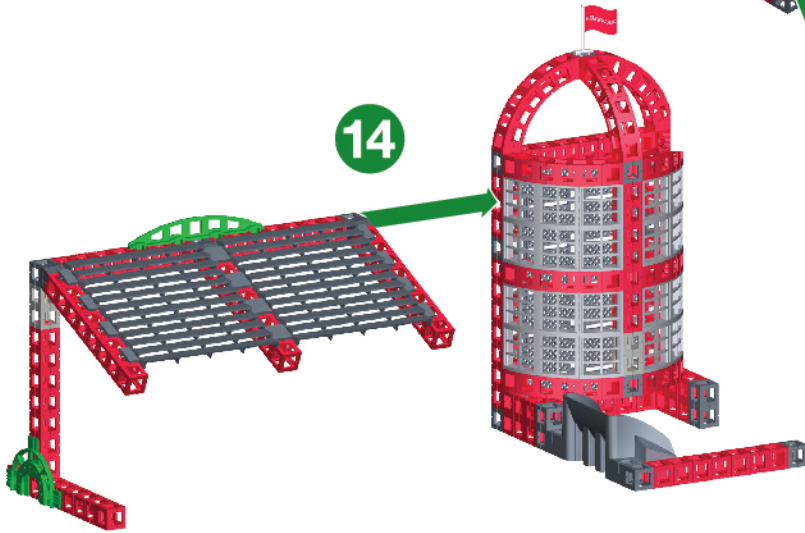

1

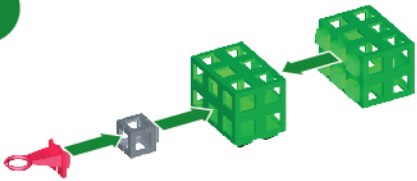

4

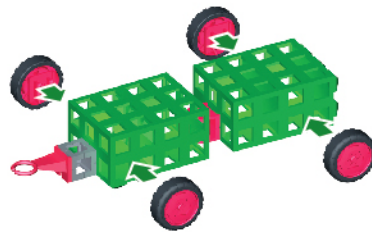

2

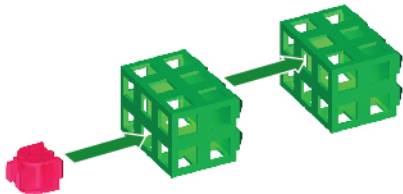

5

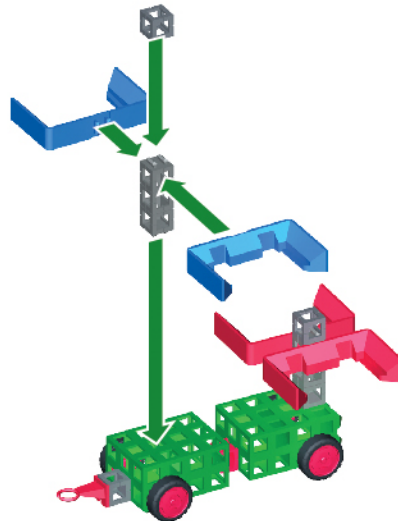

3

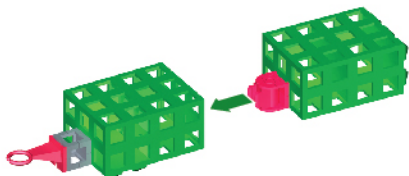

Battery Installation and Operation

- Rokenbok recommends premium alkaline batteries for use in your Rokenbok machines.
- Batteries are to be inserted with correct polarity as shown.
- Do not mix old and new batteries.
- Do not mix alkaline, standard (carbon-zinc) or nickel cadmium batteries.

Skip Track

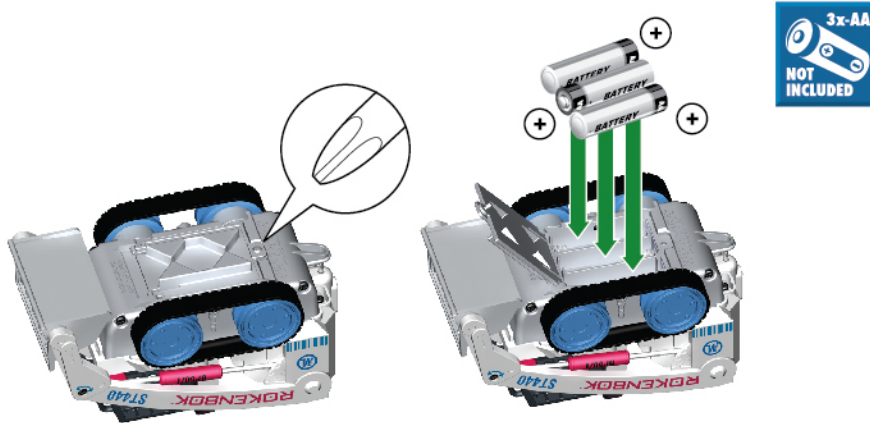

1. Press the on/off pushbutton on your Rokenbok machine. The lights will come on and an ascending tone will be heard.

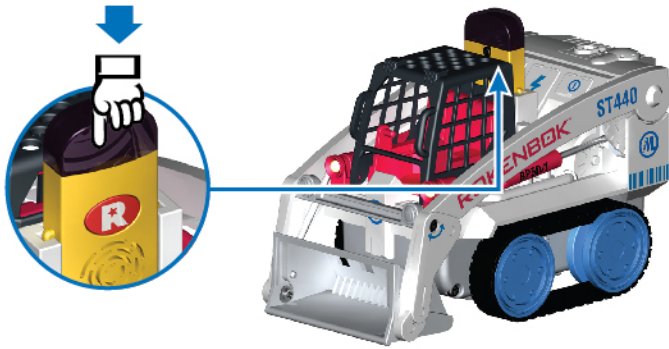

2. Select Your Machine

Press and hold the **R** select button on the ROK Star Controller and aim the controller at the machine's receiver as shown. When a ringing chime is heard release the **R** button and the machine is in your control.



3. Operation

For optimal control aim the controller at the Rokenbok machine.

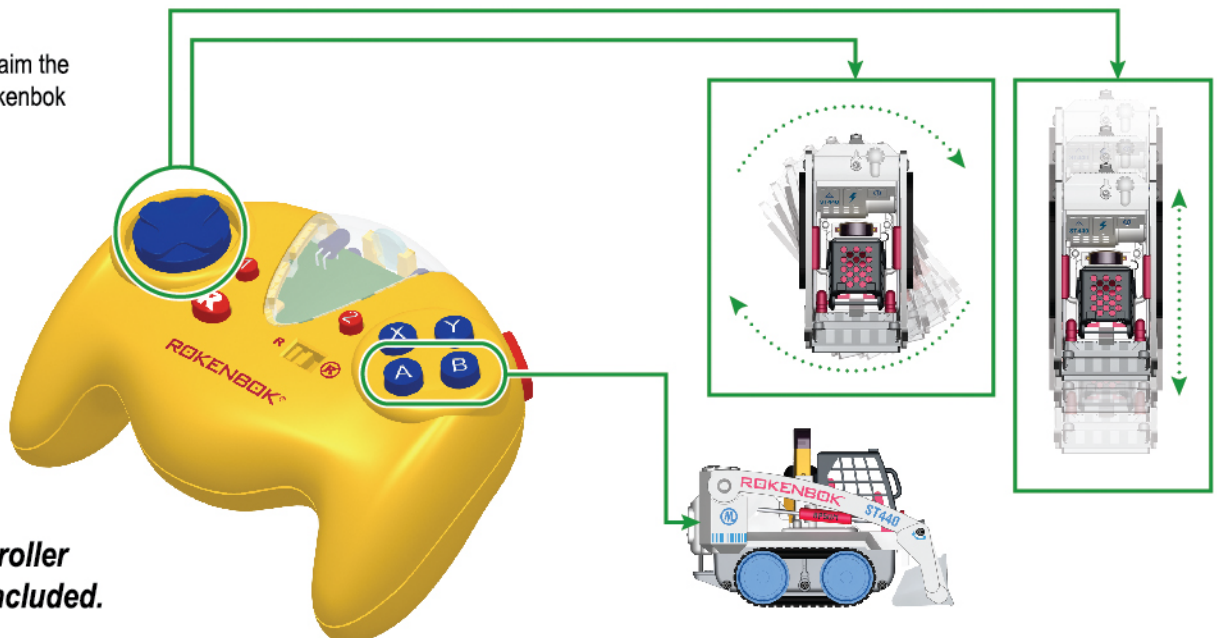

ROK Star Controller required, not included.

ROK Star is a unique technology that lets you:

- Control any number of Rokenbok machines with a single, wireless controller.
- Switch between vehicles on the go.
- Everyone can play! Add as many ROK Star controllers as you want.



©2011 Rokenbok Toy Company. All rights reserved. ROKENBOK® is a registered trademark of the Rokenbok Toy Company.

The Rokenbok system was created with your child's best interests in mind. All Rokenbok products are designed for high quality, precision and safety, and conform to the requirements of ASTM F963.

Lifetime warranty on Control Electronics and building components.

All Rokenbok Machines are warranted against defects in material and workmanship for a period of six months from the date of original purchase when used under normal operating conditions.

Only batteries of the same or equivalent type as recommended are to be used.

Please retain this information as it contains important information regarding the use of this product.

The tracking information is located on the underside of each machine.

Product may vary from photography shown

For indoor use only.

Made in China.

Rokenbok Toy Company

Solana Beach, CA (USA) Phone (858) 259-4433

1-888-4ROKBOK (1-888-476-5265)

e-mail: customerservice@rokenbok.com

www.rokenbok.com